

Raised bed canopy

No Tools Required

Before You Start







Please check the pack contents before attempting to construct this 'Raised bed canopy'.

Assembly

1. Assemble as shown (Fig. 1)
2. When fitting cover (10) ensure frame is tightly pushed together and the two panels are unzipped prior to sliding over frame, failure to do so may cause damage to the cover.
3. Secure to frame with ties attached to inside of cover.
4. When used with the Gardman or other 1m² raised beds, the canopy should be secured inside the frame. Always push the corner spikes firmly into the ground to secure the unit.

Parts & Fittings Supplied

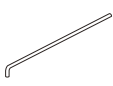
Please check the pack contents before attempting to construct this 'Multi Cloche'.

1A	4A	5A	6	7	9	10
						
x 6	x 2	x 1	x 4	x 6	x 6	x 1

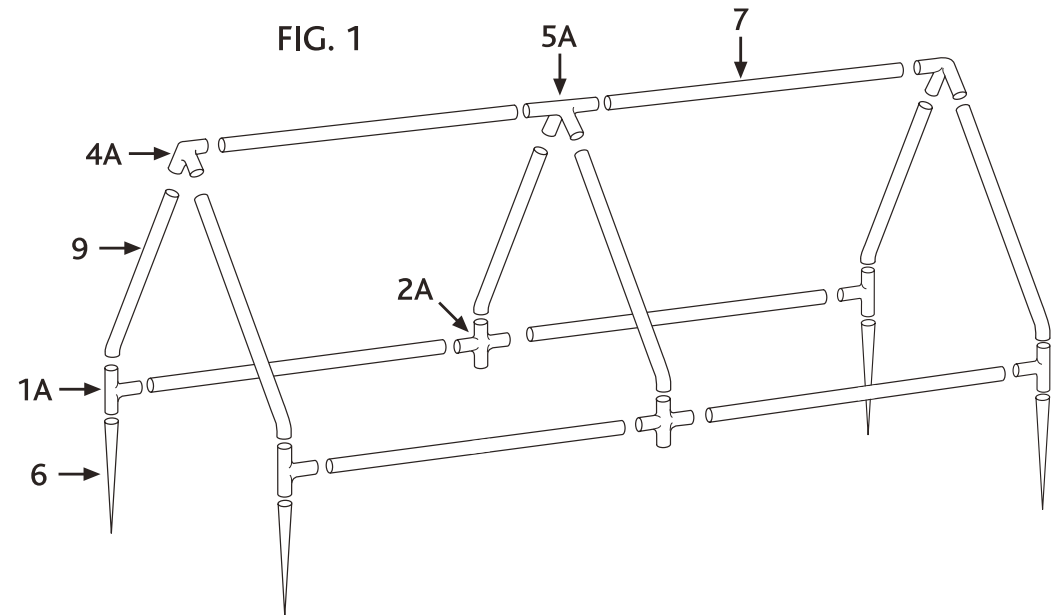

Helpline Number

If you have any problems or queries with this product please call our helpline on +44 (0)1406 372227 between the hours of 9am to 5.30pm Monday to Friday.