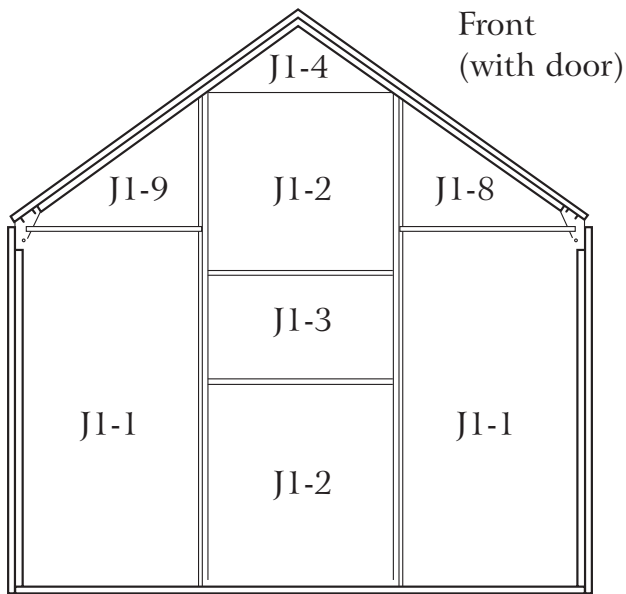
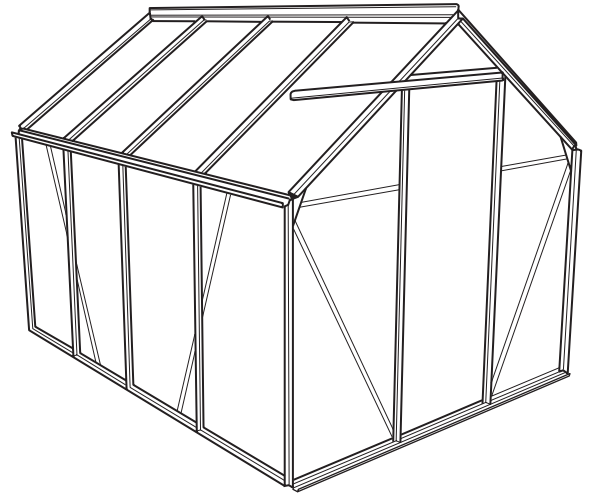




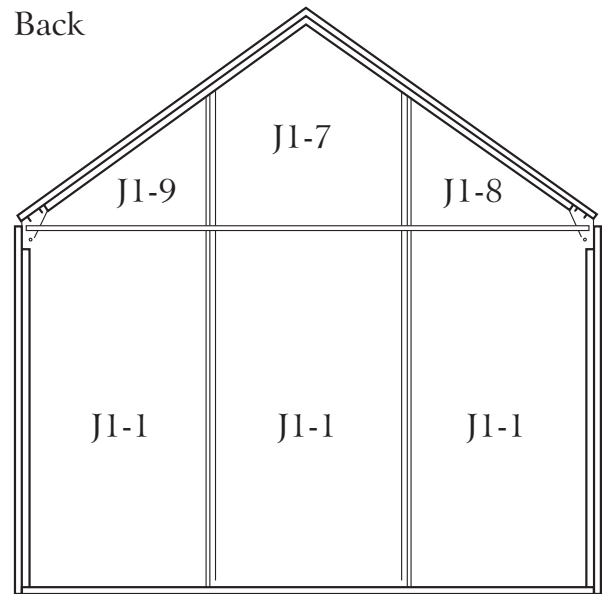
# Polycarbonate Glazing Instructions

## Important.

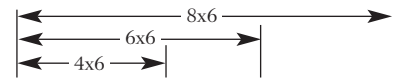
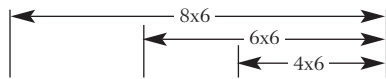
Please read the instructions completely before starting assembly.



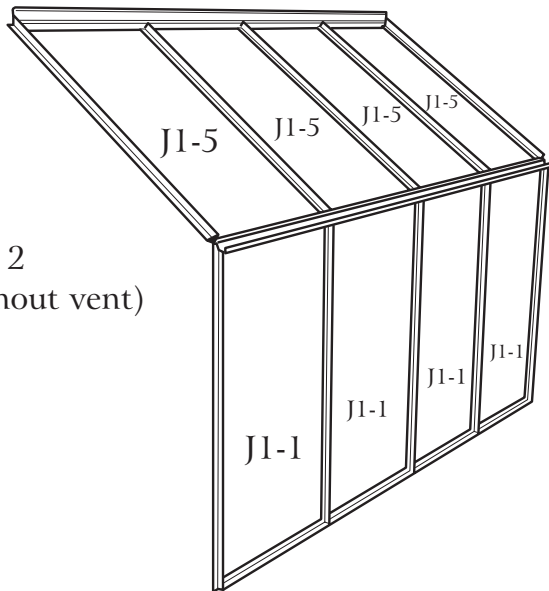
Front  
(with door)



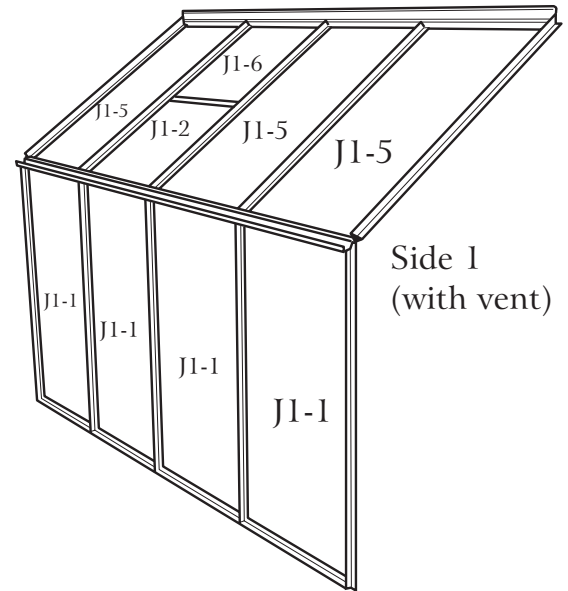
Back



Side 2  
(without vent)





















Side 1  
(with vent)



# Parts List

## Greenhouse Sizes

Profile	4 x 6	6 x 6	8 x 6	Description	Size (mm)	Code
	9	11	13	Side & End Long Sheets	617 x 1215	J1-1
	2	3	3	Large Door & Small Roof Sheets	617 x 608	J1-2
	1	1	1	Door small (middle)	617 x 226	J1-3
	1	1	1	Front end apex	617 x 233/16	J1-4
	4	5	7	Roof Long sheets	617 x 1140	J1-5
	0	1	1	Vent Sheet	605 x 545	J1-6
	1	1	1	Back end apex	617 x 670/448	J1-7
	2	2	2	Front & Back right corners	617 x 440/20	J1-8
	2	2	2	Front & Back left corners	617 x 440/20	J1-9
	5	5	5	H profile joiners	615	J2-1
	23	29	35	U profile end caps-main	615	J3-1
	4	4	4	U profile end caps-apex	380	J3-2
	0	1	1	U profile end caps-vent	545	J3-3
	4	4	4	U profile end caps-corners	745	J3-4
	144	172	204	Spring Glazing Clips (from Greenhouse frame pack)		G4
	4	6	8	Stainless Steel roof Glazing clips	25	J4-1
	13	17	21	Stainless Steel general Glazing clips	15	J4-2
	6	6	6	Stainless Steel door Glazing clips	10	J4-3

## Section 1

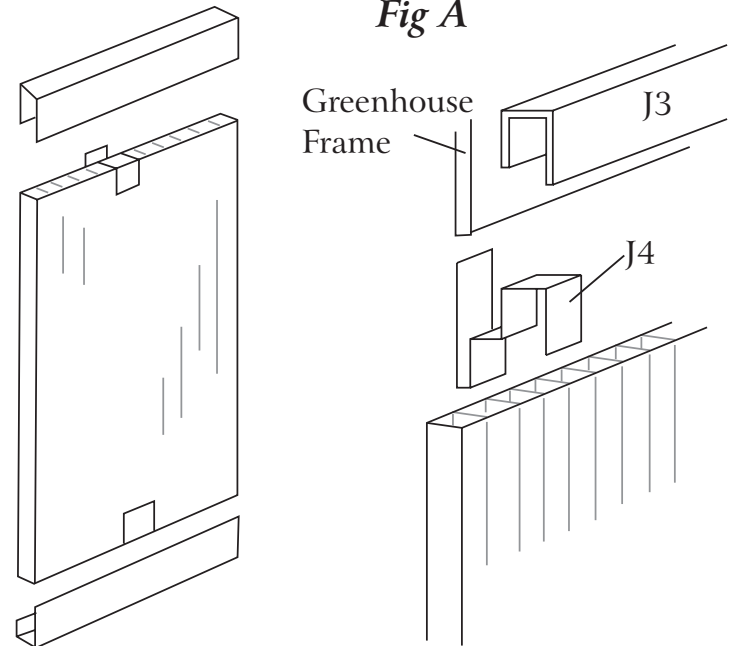
Before you start:

- This task is accomplished more easily with two people.
- Gloves and goggles are recommended. No tools required.
- Identify all Polycarbonate panels and PVC profiles.
- Locate and identify the stainless steel glazing clips from the greenhouse pack.
- Locate 'W' glazing clips from the greenhouse pack.
- It is important to install the panels with the UV treated side facing outwards. This is covered with white polythene. Suggested installation procedure:
  - Remove the clear polythene protective cover from the 'inside' face of the panel just before installation but leave the white 'outside' covering in place.
  - Install the panel, peeling back sufficient of the white sheet to install the clips and end caps.
  - Do not remove the white covering until the panel is finally secured in place.

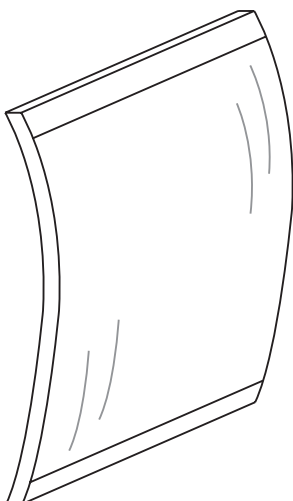
## Section 2

Glazing method: general.

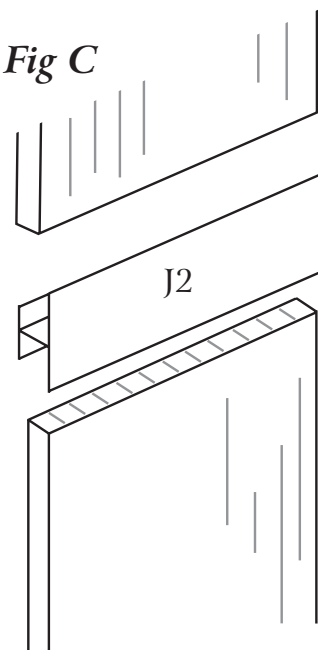
- The stainless steel glazing clips are designed to hold the centre of the polycarbonate panels to the greenhouse frame: There are 3 designs, each for a specific part of the greenhouse. Where they are needed, add the correct clip to the centre of the polycarbonate panel ends, with the frame-fixing part of the clip on the inside.
- The 'U' profile PVC strips are added before glazing and fit over the stainless steel clips where they are used. The wide face of the PVC profile should face outwards. *Fig A.*
- Have someone inside the greenhouse to help locate the stainless steel clips onto the greenhouse frame. This is best achieved by locating the bottom edge of the panel into the frame first and bending the panel as shown to locate the top edge. *Fig B.*
- The 'H' profile joiner strips (J2-1) join the polycarbonate panels at the greenhouse ends. *Fig C.*
- Once in place, secure with 'W' clips (G4) as shown, evenly spaced. *Fig D.*



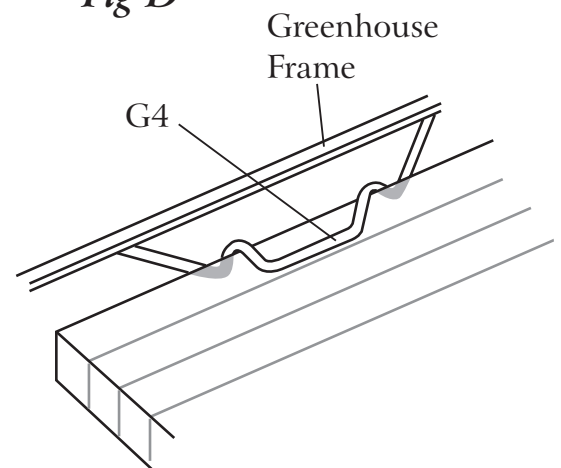
*Fig B*



*Fig C*

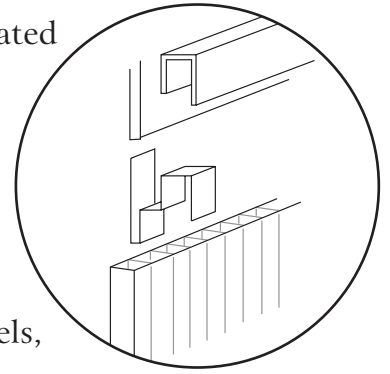


*Fig D*



Glazing: side panels.

- Use stainless steel clips J4-2 and PVC profiles J3 and proceed as indicated in the general glazing instructions.
- Once in place, secure with 'W' glazing clips G4 as shown, four 'W' clips to each side.
- Repeat for the other side panels.



Glazing: Lower end panels, back and front:

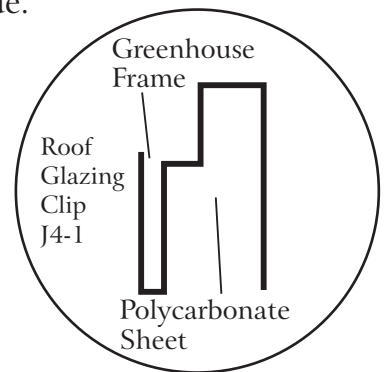
- The bottom edge of these panels is glazed in the same as the side panels, using stainless steel clips J4-2 and PVC profiles J3.
- The top edges of the panels have no glazing Z clips and use the 'H' PVC profile J2-1. (The top panels in the end section then fit into the top of these 'H' profiles).
- Once in place, secure with 'W' clips G4, four clips to each panel side.

Glazing: upper panels on greenhouse back and front.

- No glazing Z clips are used.
- The top edges have 'U' profile PVC covers as below.
  - Front apex panel: J3-2
  - Back centre panel: J3-2
  - Corner panels back and front: J3-4
- The bottom edges fit into the 'H' channel on the lower panels.
- Once in place, secure panels with 'W' clips G4, two per each panel side.

Glazing: roof.

- The panel top edges have no Z clips or PVC covers: they slide under the ridge greenhouse flange.
- The bottom edge of these uses stainless steel clips J4-1 and PVC profiles J3-1.
- Where a vent is fitted, a short panel is used below the vent opening (J1-2) and is secured in the same way.
- Once in place, secure with 'W' clips G4, four clips to each panel side.

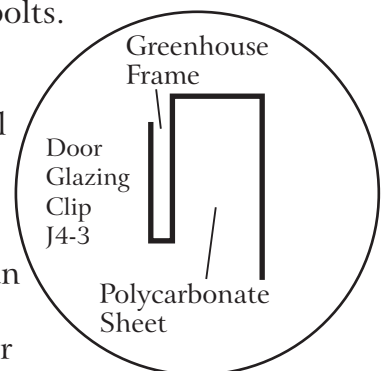


Glazing: vent.

- This section is glazed prior to installation: see greenhouse erection instructions.
- PVC profile J3-3 can be added to the panel by slackening the corner bolts.

Glazing: door.

- The top and bottom edges of all of the door panels have stainless steel clip J4-3 and PVC profile J3-1
- Once in place, secure with 'W' clips G4, two per each panel side.



NOTE: in very exposed areas extra 'W' clips are recommended: these can be purchased from most greenhouse retailers and are part of the Gardman Handy Pack range. In extreme conditions 'Sealoflex' or other clear silicon mastic can be applied to the glazing bead during the glazing process.